



CO
CO

ARKOSLIGHT



Compact and powerful

New generation LED. **154 lm/W**
luminous efficacy. A compact aluminium
cylinder with a **flux of 1340 lm.**



Freedom of movement

360° rotation and **90°** tilt.



COCO



20°

34°

48°

COCO 48V TUNABLE WHITE



28°

42°

54°

Freedom of illumination

Three opening beams **spot** / **medium** / **flood** + **Super spot 12°** version.
Fulfills multiple needs: accent lighting, general lighting, ...

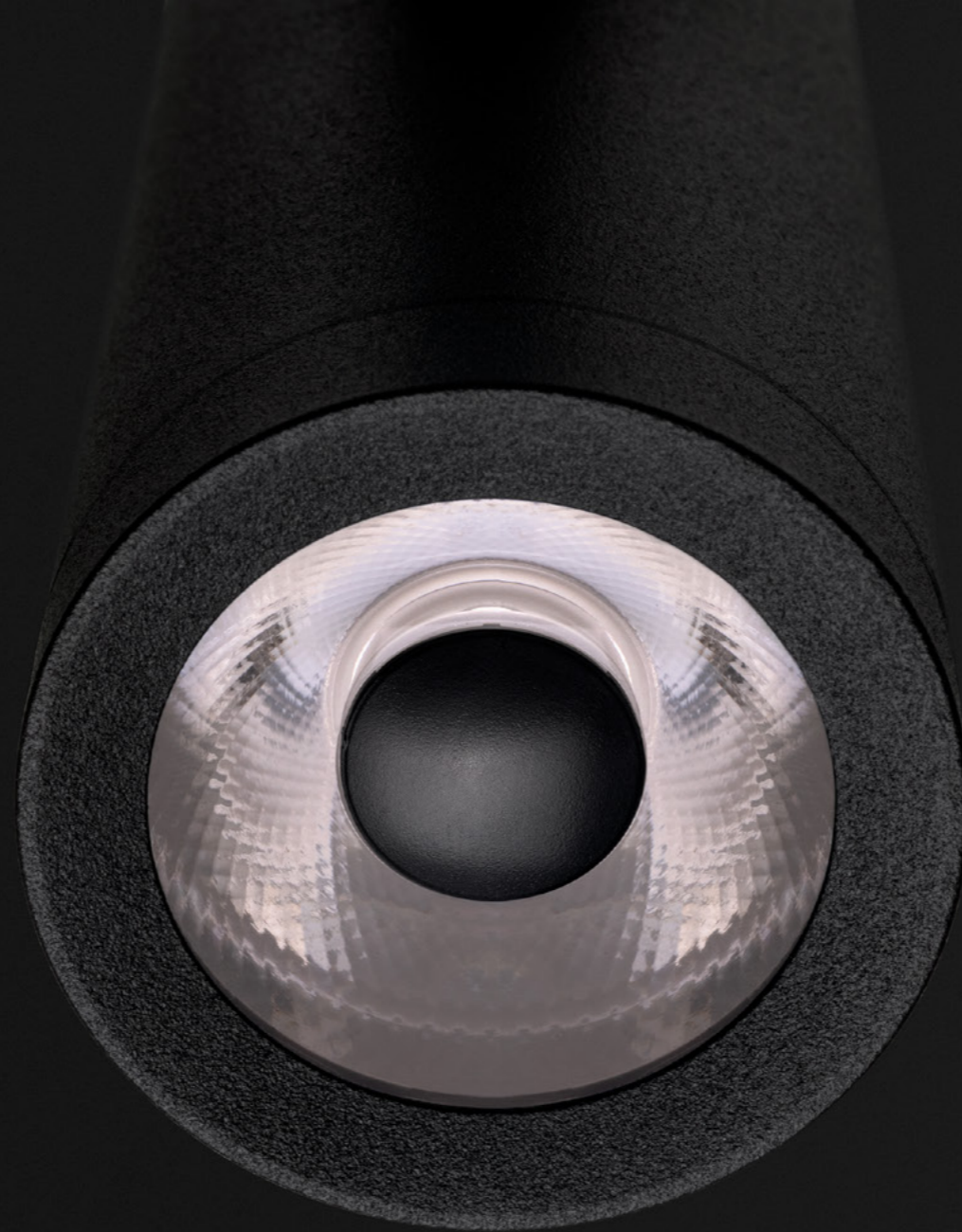

Coco Super Spot

Highly technical (**light beam aperture of 12°**).
Carefully selected high quality LEDs and lenses.
Keeps uniform flux and a pronounced visual comfort.

DIM on board option

Perfect integration for 48V systems. Allows to modulate the light intensity from **0** to **100** for each luminaire independently.



Accessories

Available with different accessories:
anti-glare honeycomb and
anti-glare screen, which reduce
glare and promote visual comfort.



COCO ANTI-GLARE SCREEN



COCO ANTI-GLARE
HONEYCOMB LOUVER

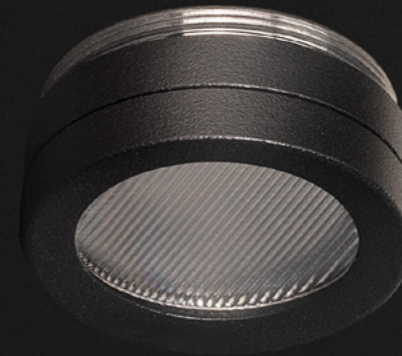



Linear Filter

The linear filter transforms the circular light beam into a **linear shape**. Ideal for applications where precise, linear light distribution is required.



MAGNETIC 24V COCO



8:20h · 3700K



12:00h · 5000K



17:00h · 2700K

Tunable white

Available for Coco 48V. Highly appreciated in domestic environments, hospitality, office, etc.

COCO
TECHNICAL
SPECIFICATIONS





MAGNETIC 24V COCO

OPTIONAL ACCESSORIES

COCO Anti-glare Honeycomb Louver**

A498-90-00- | WT | NT |



COCO Linear Filter**

A498-90-02- | WT | NT |

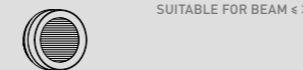

COCO Anti-glare Screen**

A498-90-01- | WT | NT |



COCO High Chromatic Led** ⓘ » 281

NOT SOLD SEPARATELY

TRIMLESS TOOL D16 X D34mm

A478-00-00

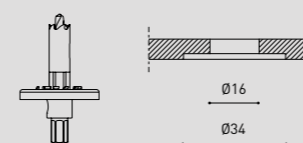

		P	CCT	Beam	I	Flux	LOR
MAGNETIC 24V COCO	A499-00-10- WT NT	8,7W	2700K	20°	500mA	1200 lm	87%
	A499-00-11- WT NT	8,7W	3000K	20°	500mA	1250 lm	87%
	A499-00-12- WT NT	8,7W	4000K	20°	500mA	1340 lm	87%
	A499-00-20- WT NT	8,7W	2700K	34°	500mA	1200 lm	89%
	A499-00-21- WT NT	8,7W	3000K	34°	500mA	1250 lm	89%
	A499-00-22- WT NT	8,7W	4000K	34°	500mA	1340 lm	89%
	A499-00-30- WT NT	8,7W	2700K	48°	500mA	1200 lm	86%
	A499-00-31- WT NT	8,7W	3000K	48°	500mA	1250 lm	86%
	A499-00-32- WT NT	8,7W	4000K	48°	500mA	1340 lm	86%

24 V | ⓘ IP20 | CRI>90 | L80B10 > 66.000h



		P	CCT	Beam	I	Flux	LOR
MAGNETIC 24V COCO Super Spot	A499-00-00- WT NT	6W	2700K	12°	500mA	750 lm	66%
	A499-00-01- WT NT	6W	3000K	12°	500mA	800 lm	66%
	A499-00-02- WT NT	6W	4000K	12°	500mA	850 lm	66%

24 V | ⓘ IP20 | CRI>90 | L80B10 > 55.000h

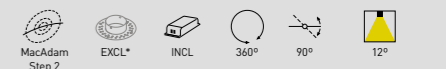

MAGNETIC 24V CONNECTOR A435-01-00 | W | N |

* MANDATORY FOR INSTALLATION

ⓘ IP20 | ⓘ Ø16

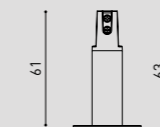
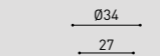

INCLUDED EXTRA COVER FOR RECESSED VERSION

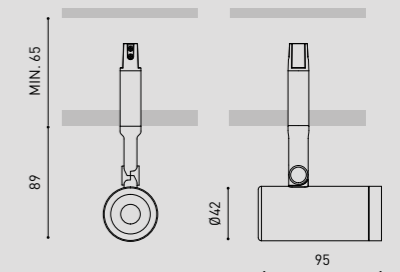

		P	V	D (A x B x C)
24V POWER SUPPLY	0434-01-37	60W	24V	180 x 52 x 30mm
	0433-10-22	100W	24V	295 x 43 x 30mm

220-240 V~ | MUST BE PLACED ON REMOTE

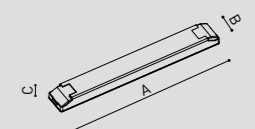

			V	D (A x B x C)
24V DIMMER	0433-01-32	DALI / Push	24V	181 x 42 x 20mm
	0433-01-33	CASAMBI	24V	172 x 42 x 20mm
	0434-01-64	WIFI	24V	105 x 44 x 23mm

24 V | MUST BE PLACED ON REMOTE
OTHER DIM OPTIONS PLEASE CONSULT

ⓘ DROP VOLTAGE » 287

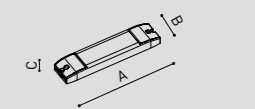

COLOUR | WT □ | NT ■ | MATERIAL | AL | PC/PMMA |

PLEASE CONSULT » ⓘ

OTHER CCT OPTIONS PLEASE CONSULT
** AFFECTS THE LIGHTING PARAMETERS



COCO 48V

OPTIONAL ACCESSORIES

AFFECT THE LIGHTING PARAMETERS

COCO Anti-glare Honeycomb Louver

A498-90-00- | WT | NT |



COCO Anti-glare Screen

A498-90-01- | WT | NT |



COCO Linear Filter

A498-90-02- | WT | NT |

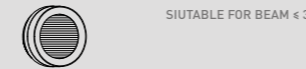

COCO High Chromatic Led

NOT SOLD SEPARATELY

FINISHING

FINISHING	Lamp	Adaptor
WT	WT □ N ■	
NT	NT ■ N ■	
WTW	WT □ W □	
NTW	NT ■ W □	

COCO 48V	+RE	P	CCT	Beam	I	Flux	LOR
A498-0- 00 -10- WT NT WTW NTW -S		8,7W	2700K	20°	500mA	1200 lm	87%
A498-0- 00 -11- WT NT WTW NTW -S		8,7W	3000K	20°	500mA	1250 lm	87%
A498-0- 00 -12- WT NT WTW NTW -S		8,7W	4000K	20°	500mA	1340 lm	87%
A498-0- 00 -20- WT NT WTW NTW -S		8,7W	2700K	34°	500mA	1200 lm	89%
A498-0- 00 -21- WT NT WTW NTW -S		8,7W	3000K	34°	500mA	1250 lm	89%
A498-0- 00 -22- WT NT WTW NTW -S		8,7W	4000K	34°	500mA	1340 lm	89%
A498-0- 00 -30- WT NT WTW NTW -S		8,7W	2700K	48°	500mA	1200 lm	86%
A498-0- 00 -31- WT NT WTW NTW -S		8,7W	3000K	48°	500mA	1250 lm	86%
A498-0- 00 -32- WT NT WTW NTW -S		8,7W	4000K	48°	500mA	1340 lm	86%

48 V | IP20 | CRI>90 | L80B10 >66.000h



COCO 48V Super Spot

COCO 48V Super Spot	+RE	P	CCT	Beam	I	Flux	LOR
A498-0- 00 -00- WT NT WTW NTW -S		6W	2700K	12°	500mA	750 lm	66%
A498-0- 00 -01- WT NT WTW NTW -S		6W	3000K	12°	500mA	800 lm	66%
A498-0- 00 -02- WT NT WTW NTW -S		6W	4000K	12°	500mA	850 lm	66%

48 V | IP20 | CRI>90 | L80B10 >55.000h



COCO 48V Tunable White

COCO 48V Tunable White	+RE	P	CCT	Beam	I	Flux	LOR
A498-12-18- WT NT WTW NTW -S		8,5W	2700-5000K	28°	500mA	1010 lm	85%
A498-12-28- WT NT WTW NTW -S		8,5W	2700-5000K	42°	500mA	1010 lm	87%
A498-12-38- WT NT WTW NTW -S		8,5W	2700-5000K	54°	500mA	1010 lm	84%

48 V | IP20 | CRI>90 | L80B10 >55.000h



*OPTIONS

1	No DIM
2	DIM DALI
7	DIM ON BOARD

OTHER DIM OPTIONS PLEASE CONSULT

+RE REF. ENDING EXAMPLE

0	Track 48V	A4980110WT
-S	Track 48V Short	A4980110WT-S

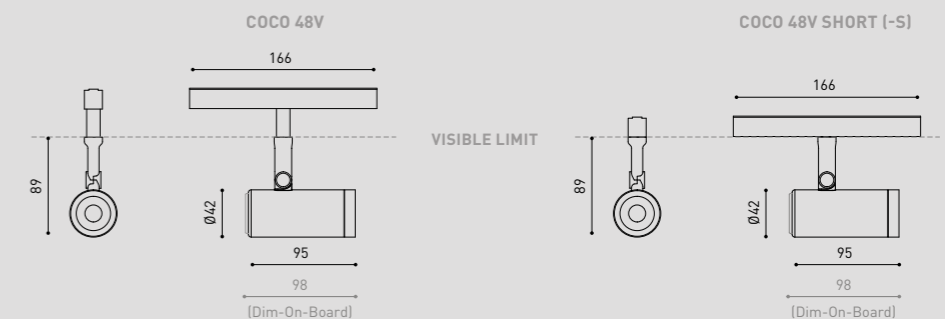

COLOUR | WT □ | NT ■ | MATERIAL | AL | PC/PMMA |

PLEASE CONSULT »

OTHER CCT PLEASE CONSULT

+RE >> THE PRODUCTS FOR THE TRACK 48V SHORT, ADD "-S" AT THE END OF THE SALES REFERENCE (AFTER THE LETTERS WHICH INDICATE THE COLOUR OF THE PRODUCT).

OPTIONAL ACCESSORIES



COCO



COCO SUPER SPOT



COCO ANTI-GLARE HONEYCOMB LOUVER



COCO LINEAR FILTER



COCO ANTI-GLARE SCREEN

FINISHINGS



NT



WT



NTW



WTW



NT



WT



NT SUPER SPOT



WT SUPER SPOT

CO
CO

by ARKOSLIGHT