

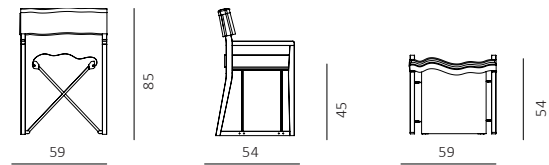

Item code: **COPOL**



### TERMS OF USE

**H** Hard Conditions: bar, pub

**SG** Seaside

**M** Medium Conditions: HORECA

### MATERIALS AND FINISHES

Teak frame



Teak

### TYPE OF PRODUCT

Assembled

### PACKAGING

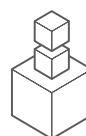

1 pz



10 Kg

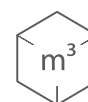

0,082 m<sup>3</sup>



89 x 55 x 17 cm

Item code: **OCPOL**

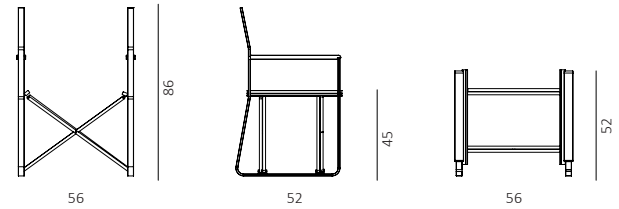

### TERMS OF USE

- H** Hard Conditions: bar, pub
- SG** Seaside
- M** Medium Conditions: HORECA

### MATERIALS AND FINISHES

Aluminium frame



White



Grafite

### TYPE OF PRODUCT

Assembled

### PACKAGING

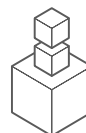

1 pz



7 Kg

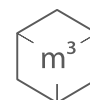

0,116 m<sup>3</sup>



93 x 57 x 22 cm

Item code: **PEVDI2P**

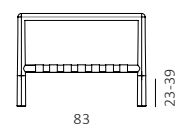
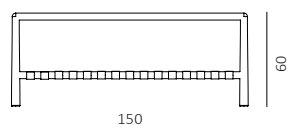
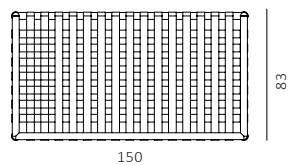

## TERMS OF USE

- H** Hard Conditions: bar, pub
- SG** Seaside
- M** Medium Conditions: HORECA

## MATERIALS AND FINISHES

Teak frame



Teak

## TYPE OF PRODUCT

Assembled

## PACKAGING

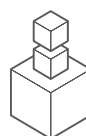

1 pz



28 Kg

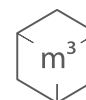

0,856 m<sup>3</sup>



155 x 86 x 65 cm

Item code: **PEVDI3P**

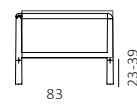
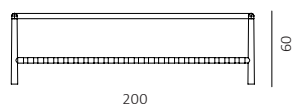
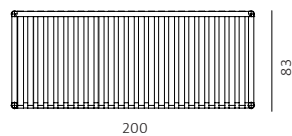

## TERMS OF USE

**H**

Hard Conditions: bar, pub

**SG**

Seaside

**M**

Medium Conditions: HORECA

## MATERIALS AND FINISHES

Teak frame



Teak

## TYPE OF PRODUCT

Assembled

## PACKAGING

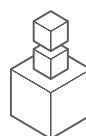

1 pz



39 Kg

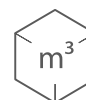

1,165 m<sup>3</sup>



207 x 88 x 65 cm

Item code: **PEVPOL**

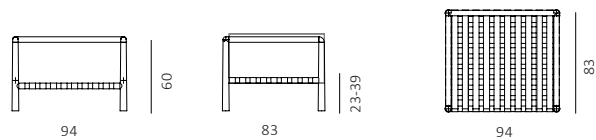

## TERMS OF USE

- H** Hard Conditions: bar, pub
- SG** Seaside
- M** Medium Conditions: HORECA

## MATERIALS AND FINISHES

Teak frame



Teak

## TYPE OF PRODUCT

Assembled

## PACKAGING

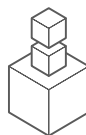

1 pz



23 Kg

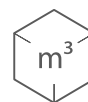

0,557 m<sup>3</sup>

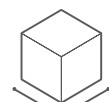

98 x 88 x 65 cm

Item code: **PEVISO**

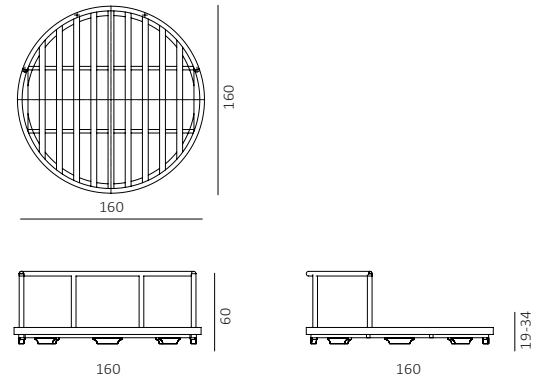

## TERMS OF USE

- H** Hard Conditions: bar, pub
- SG** Seaside
- M** Medium Conditions: HORECA

## MATERIALS AND FINISHES

Teak frame



Teak

## TYPE OF PRODUCT

Assembled

## PACKAGING

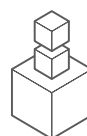

1 pz



60 Kg

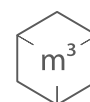

1,758 m<sup>3</sup>



166 x 163 x 65 cm

Item code: **PEVLET**

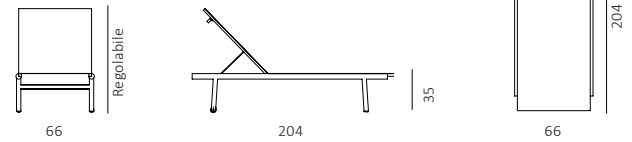

### TERMS OF USE

- H** Hard Conditions: bar, pub
- SG** Seaside
- M** Medium Conditions: HORECA

### MATERIALS AND FINISHES

Teak frame



Teak

### TYPE OF PRODUCT

Assembled

### PACKAGING

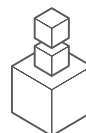

1 pz



20 Kg

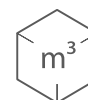

0,584 m<sup>3</sup>



208 x 75 x 38 cm

Item code: **PEVSETC**

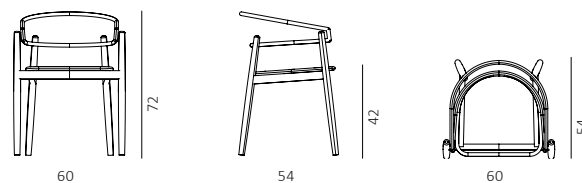

## TERMS OF USE

**H**

Hard Conditions: bar, pub

**SG**

Seaside

**M**

Medium Conditions: HORECA

## MATERIALS AND FINISHES

Teak frame



Teak

## TYPE OF PRODUCT

Assembled

## PACKAGING

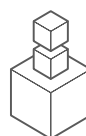

2 pz



20 Kg

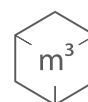

0,330 m<sup>3</sup>



68 x 64 x 76 cm



Item code: **PEVSTAB**

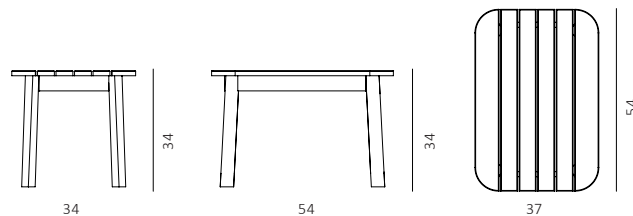

## TERMS OF USE

- H** Hard Conditions: bar, pub
- SG** Seaside
- M** Medium Conditions: HORECA

## MATERIALS AND FINISHES

Teak frame



Teak

## TYPE OF PRODUCT

To be assembled

## PACKAGING

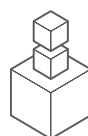

1 pz



5 Kg

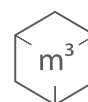

0,025 m<sup>3</sup>



60 x 42 x 10 cm

Item code: **PEVTAQ80**

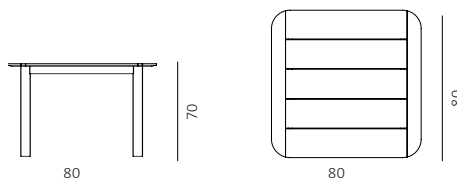

## TERMS OF USE



Hard Conditions: bar, pub



Seaside



Medium Conditions: HORECA

## MATERIALS AND FINISHES

Teak frame



Teak

## TYPE OF PRODUCT

To be assembled

## PACKAGING

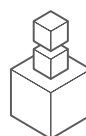

1 pz



21 Kg

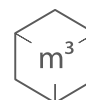

0,072 m<sup>3</sup>



85 x 85 x 10 cm

Item code: **PEVTARE160**

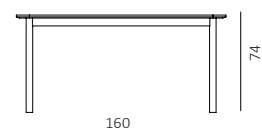
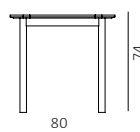
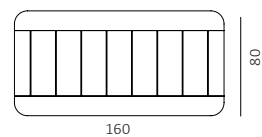

## TERMS OF USE

- H** Hard Conditions: bar, pub
- SG** Seaside
- M** Medium Conditions: HORECA

## MATERIALS AND FINISHES

Teak frame



Teak

## TYPE OF PRODUCT

To be assembled

## PACKAGING

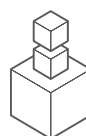

1 pz



42 Kg

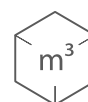

0,130 m<sup>3</sup>



185 x 85 x 10 cm

Item code: **PEVTBQ**

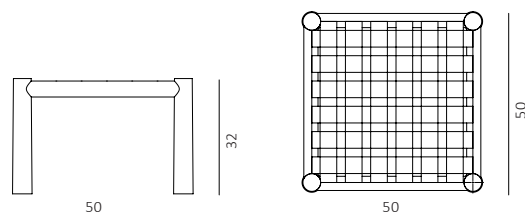

## TERMS OF USE

- H** Hard Conditions: bar, pub
- SG** Seaside
- M** Medium Conditions: HORECA

## MATERIALS AND FINISHES

Teak frame



Teak

## TYPE OF PRODUCT

Assembled

## PACKAGING

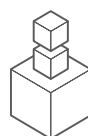

1 pz



8 Kg

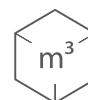

0,108 m<sup>3</sup>



56 x 56 x 36 cm

Item code: **PEVTBR**

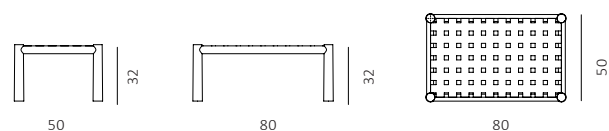

### TERMS OF USE

- H** Hard Conditions: bar, pub
- SG** Seaside
- M** Medium Conditions: HORECA

### MATERIALS AND FINISHES

Teak frame



Teak

### TYPE OF PRODUCT

Assembled

### PACKAGING

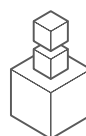

1 pz



11 Kg

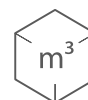

0,166 m<sup>3</sup>



84 x 55 x 37 cm

## CURA E MANUTENZIONE

### TEAK

I trattamenti a cui sottoporre il teak annualmente sono di due tipi. Manutenzione Ordinaria (semplice trattamento di pulizia e lucidatura, adatto a mobili non esposti all'esterno o di recente acquisto): lavare il mobile con sapone neutro (sapone di Marsiglia), fare asciugare completamente al sole e applicare qualche goccia di olio di teak, usando un panno di cotone (è sconsigliato l'uso del pennello in quanto creerebbe una patina che impedirebbe al teak di traspirare). Manutenzione straordinaria (trattamento di pulizia più profondo, finalizzato al ripristino della colorazione color miele): questo trattamento è consigliato per mobili esposti all'esterno che hanno già raggiunto la tipica colorazione argentea. Passare carta vetrata molto fine per togliere la patina argentata. Lavare con acqua e sapone neutro (sapone di Marsiglia) e lasciare asciugare al sole. Applicare qualche goccia di olio di teak con un pennello di media grandezza e asciugare completamente al sole. Se una volta asciugato dovesse risultare poroso (caratteristica dei pigmenti che compongono l'olio) si consiglia di passare un panno umido su tutto il mobile. Per i mobili appena acquistati si consiglia di passare un panno leggermente umido prima di posizionare i cuscini per togliere un po' di oleosità e prevenire macchie su indumenti o cuscini.

## CARE AND MAINTENANCE

### TEAK

There are two types of treatments to be applied annually. Ordinary maintenance (standard cleaning and polishing treatment suitable for recently purchased or indoor furniture): clean the furniture with neutral soap (Marseille soap), let it dry completely under the sun, apply few drops of teak oil using a soft cotton cloth (we do not recommend using a brush as it could create a patina that would prevent the teak from breathing). Deep maintenance (deeper cleansing treatment aimed at restoring the original honey color): this treatment is recommended for outdoor furniture which has reached its typical silver colour. Use very fine sandpaper to remove the natural grey patina, rinse with water and neutral soap (Marseille soap) and let fully dry under the sun. Apply few drops of teak oil with a medium-sized brush and let fully dry again under the sun. After the treatment, should the furniture be porous (characteristic of the oil pigments) we recommend wiping the entire furniture with a damp cloth. For newly purchased furniture we recommend wiping with a slightly damp cloth before placing the cushions to remove natural oils and prevent stains on the clothing and cushions.